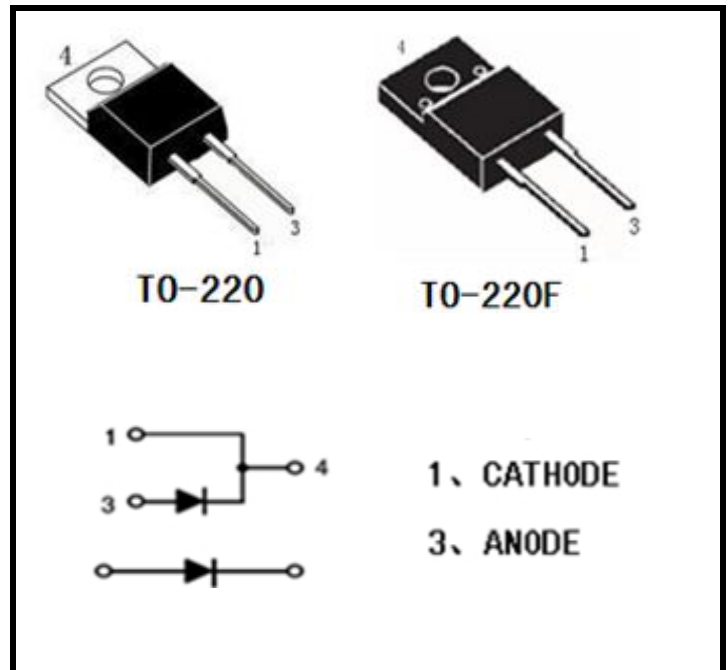

PRODUCT FEATURES

- Ultrafast Recovery Time
- Soft Recovery Characteristics
- Low Recovery Loss
- Low Forward Voltage
- High Surge Current Capability
- Low Leakage Current

APPLICATIONS

- Freewheeling, Snubber, Clamp
- Inversion Welder
- PFC
- Plating Power Supply
- Ultrasonic Cleaner and Welder
- Converter & Chopper
- UPS

ABSOLUTE MAXIMUM RATINGS
 $T_c=25^\circ\text{C}$ unless otherwise specified

Symbol	Parameter	Test Conditions	Max.	Unit
V_R	D.C. Reverse Voltage		600	V
V_{RRM}	Repetitive Reverse Voltage		600	V
$I_{F(AV)}$ (per leg)	Average Forward Current	$T_c=110^\circ\text{C}$, Duty=0.5	10	A
I_{FM}	Peak Repetitive Forward Current	$T_c=110^\circ\text{C}$, Duty=0.5	20	A
I_{FSM}	Non-Repetitive Surge Forward Current	$T=45^\circ\text{C}$, 8.3ms,	120	A
T_J	Junction Temperature		-55 to +175	$^\circ\text{C}$
T_{STG}	Storage Temperature Range		-55 to +175	$^\circ\text{C}$

ELECTRICAL AND THERMAL CHARACTERISTICS
 $T_c=25^\circ\text{C}$ unless otherwise specified

Symbol	Parameter	Test Conditions	Min.	Typ.	Max.	Unit	
I_{RM}	Reverse Leakage Current	$V_R=600\text{V}$, $T_J=25^\circ\text{C}$	--	--	25	μA	
		$V_R=600\text{V}$, $T_J=125^\circ\text{C}$	--	--	500	μA	
V_F	Forward Voltage	$I_F=10\text{A}$, $T_J=25^\circ\text{C}$	--	1.2	1.8	V	
		$I_F=10\text{A}$, $T_J=125^\circ\text{C}$	--	1	--	V	
t_{rr}	Reverse Recovery Time ($I_F=1\text{A}$, $V_R=30\text{V}$, $di_F/dt=-200\text{A}/\mu\text{s}$)		--	28	--	ns	
t_{rr}	Reverse Recovery Time	$I_F=10\text{A}$ $V_R=400\text{V}$ $di_F/dt=-200\text{A}/\mu\text{s}$	$T_J=25^\circ\text{C}$	--	50	--	ns
t_{rr}	Reverse Recovery Time		$T_J=125^\circ\text{C}$	--	80	--	ns
Q_{rr}	Reverse Recovery Charge		$T_J=125^\circ\text{C}$	--	250	--	nC
I_{RRM}	Max. Reverse Recovery Current		$T_J=125^\circ\text{C}$	--	6.5	--	A

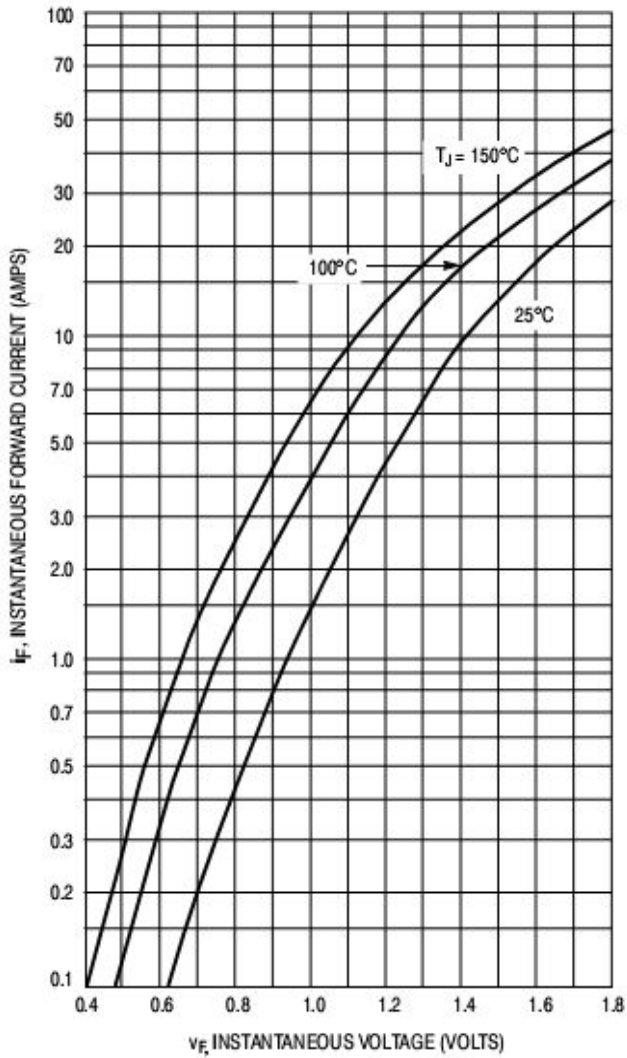

Typical Forward Voltage

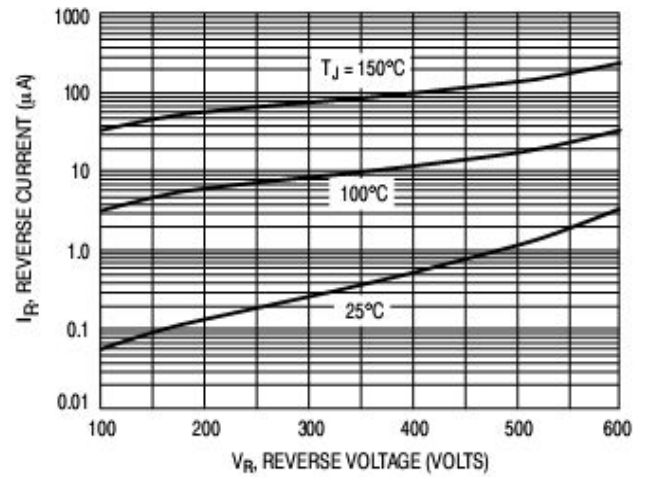

Typical Reverse Current

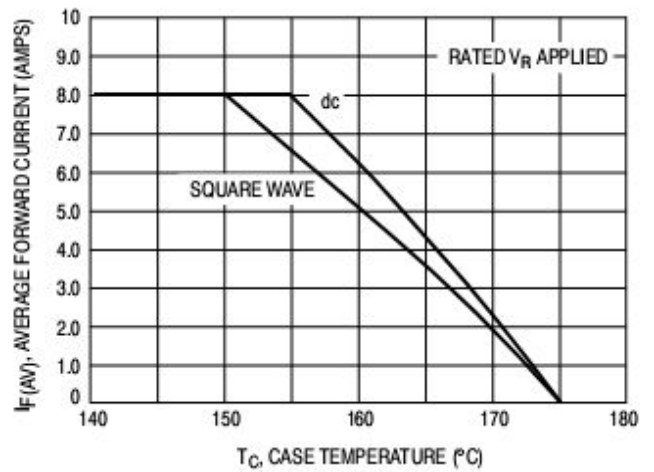

Current Derating Case

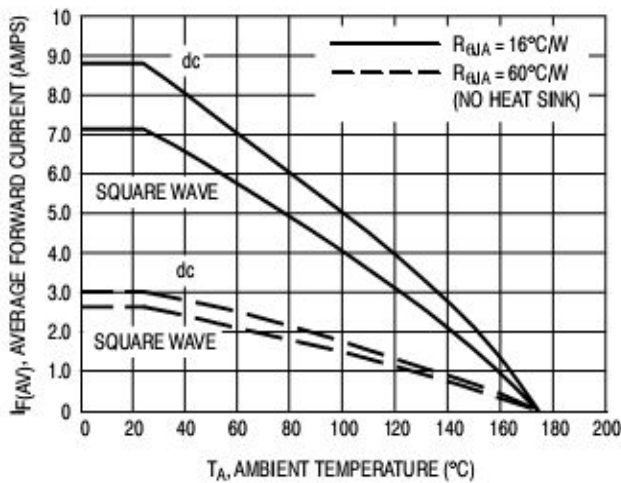

Current Derating, Ambient

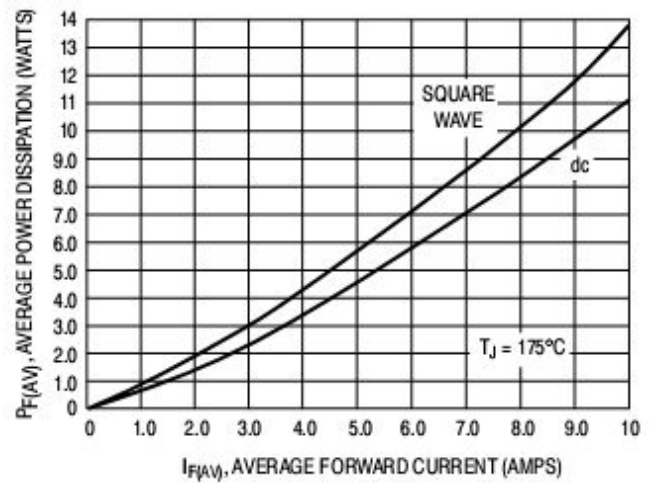

Power Dissipation

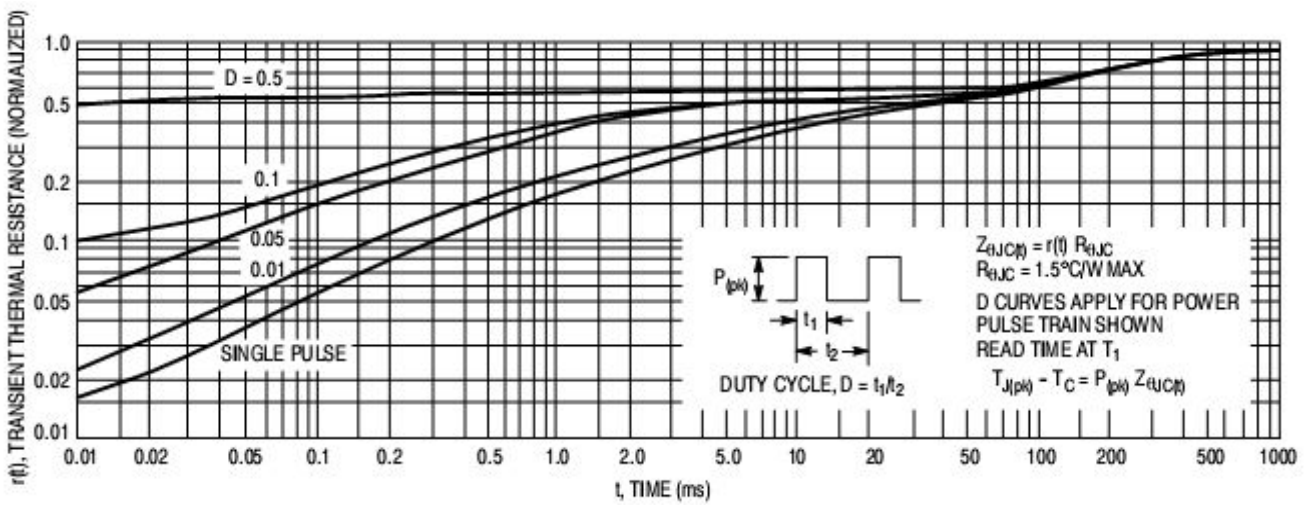

Thermal Response

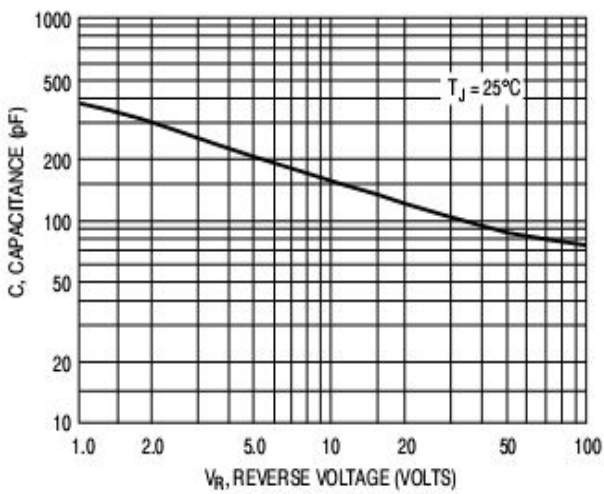

Typical Capacitance

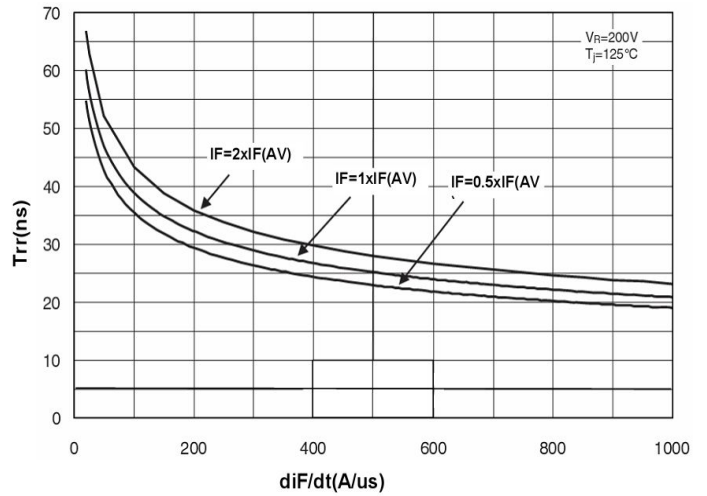

Reverse recovery time versus diF/dt (typical values)

TO-220 MECHANICAL DATA
UNIT: mm

SYMBOL	MIN	NOM	MAX	SYMBOL	MIN	NOM	MAX
A	4		4.8	e		2.54	
B	1.2		1.4	e1	1		1.5
B1	1		1.4	F	1.1		1.4
b1	0.65		1	L	12.5		14.5
c	0.4		0.55	L1	3	3.5	4
D	15		16.5	ΦP		3.8	
D1	5.9		6.9	Q	2.5		3
E	9.9		10.7	Q1	2		2.9

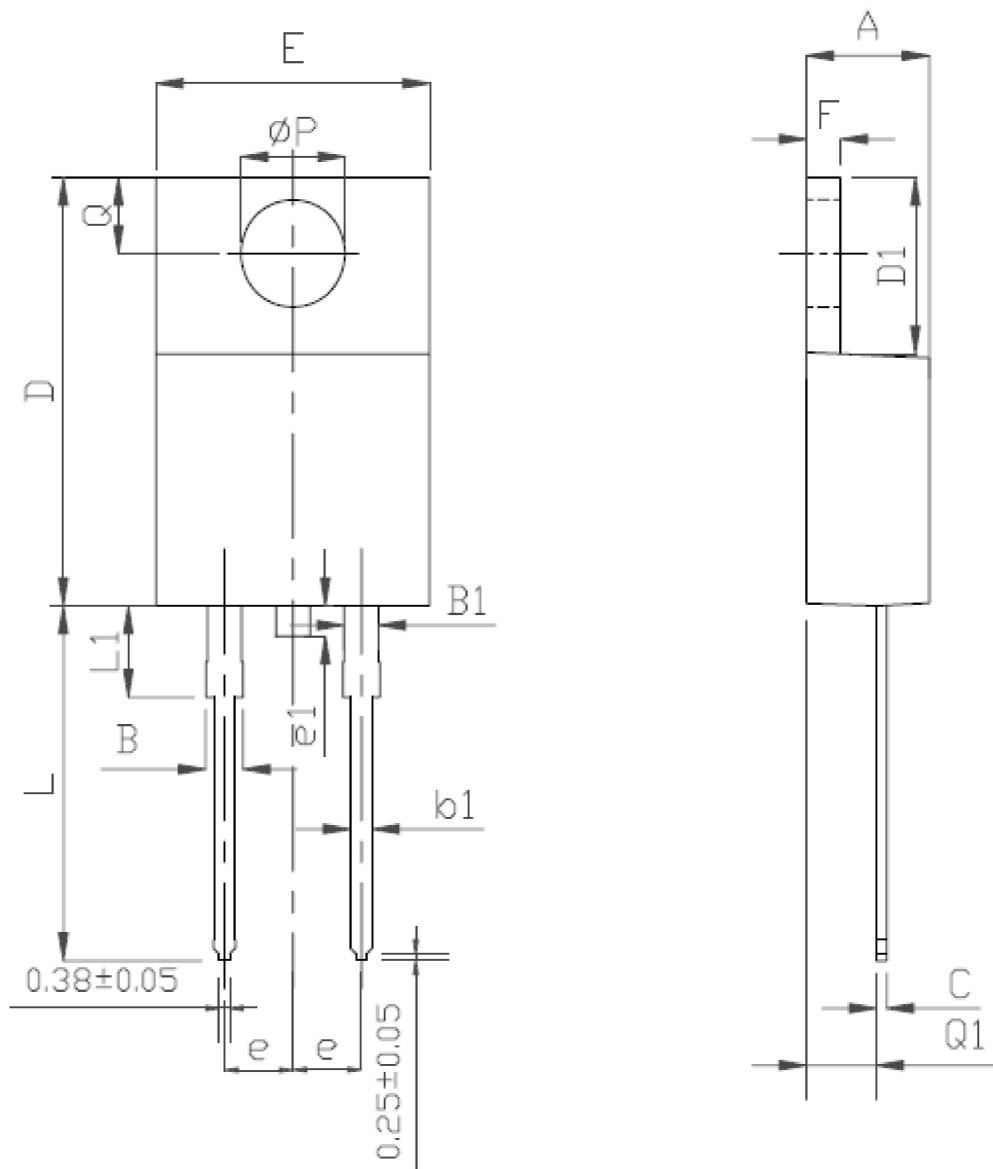

TO-220F MECHANICAL DATA
UNIT: mm

SYMBOL	MIN	NOM	MAX	SYMBOL	MIN	NOM	MAX
A	4.5		4.9	E1		7	
A1	2.3		2.9	e		2.54	
b	0.45		0.9	e1	1		1.5
b1	1.1		1.7	L	12.5		14.3
b2	1.2		1.4	L1	9.45		10.05
c	0.35		0.9	L2	15		16
D	14.5		17	L3	3.2		4.4
D1	6.1		6.9	ΦP	3		3.3
E	9.6		10.3	Q	2.5		2.9

